

AVANTAJELE INCONTESTABILE ALE BIOMASEI:

- protejeaza natura
- sursa regenerabila
- confort
- economie



AGROBI

BRICHET

SOLUTII COMPLETE LINII BRICHETARE
SI UTILAJE PELETIZARE - PELETI DIN PAIE,
RUMEGUS SI REICLARE DESEURI

Linie brichetare paie seria "BriqTech"

Capacitate productie
≤250 kg/ora brichete
Brichete din resturi vegetale
Brichete diametru 60 mm,
densitate ≤1450 kg/m.cub
Puterea instalata 45 kW

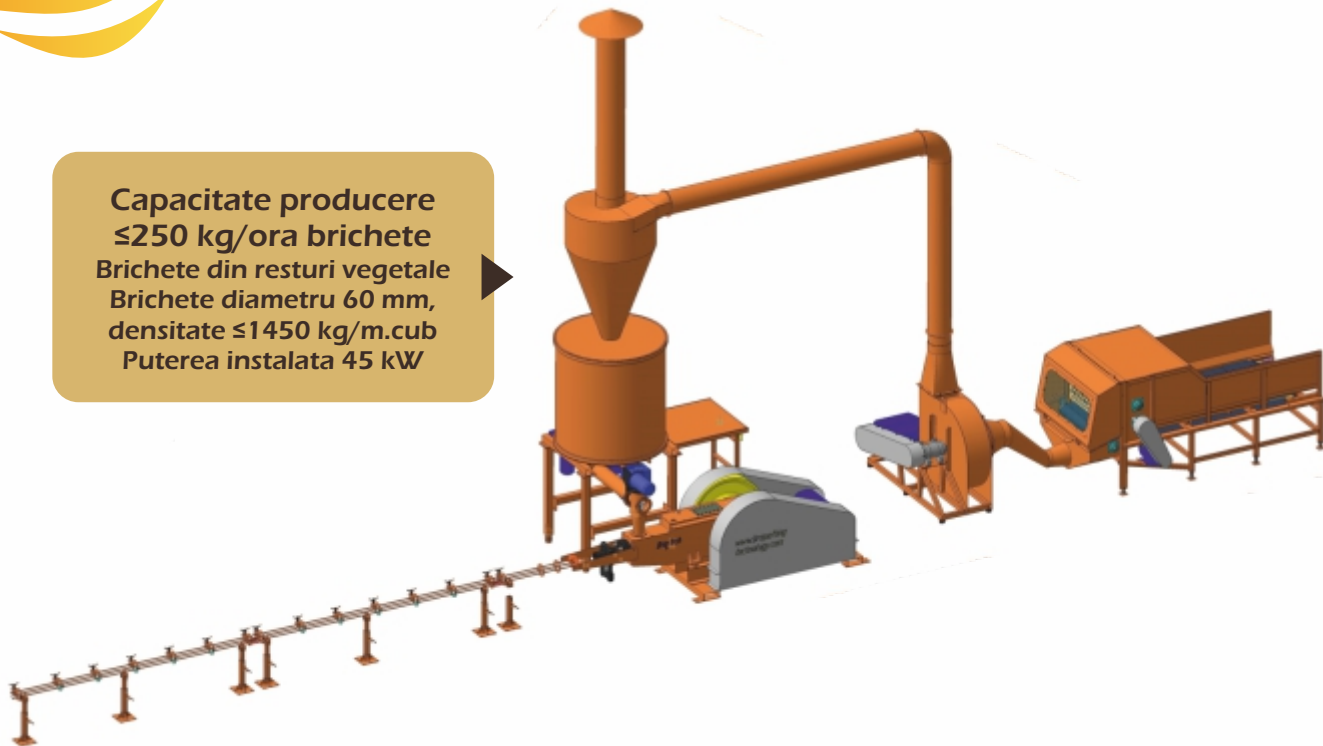

Capacitate productie
≤300-400 kg/ora brichete
Brichete din resturi vegetale
Brichete diametru 60-65mm,
densitate ≤1450 kg/m.cub
Puterea instalata 45 kW

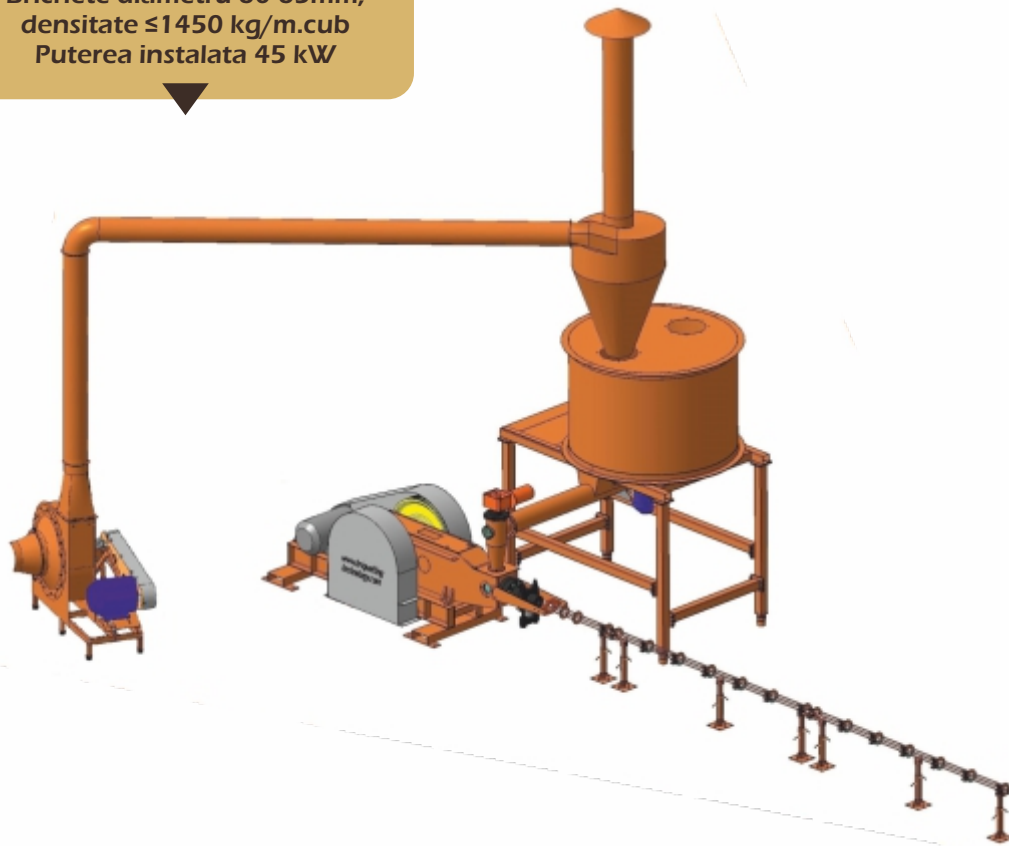

ASIGURAM MENTENANTA, SERVICE, PIESE DE SCHIMB



Linie brichetare paie seria "BriqTech"

Capacitate productie
≤400-500 kg/ora brichete
Brichete din resturi vegetale
Brichete diametru 65-70mm,
densitate ≤1450 kg/m.cub
Puterea instalata 100 kW

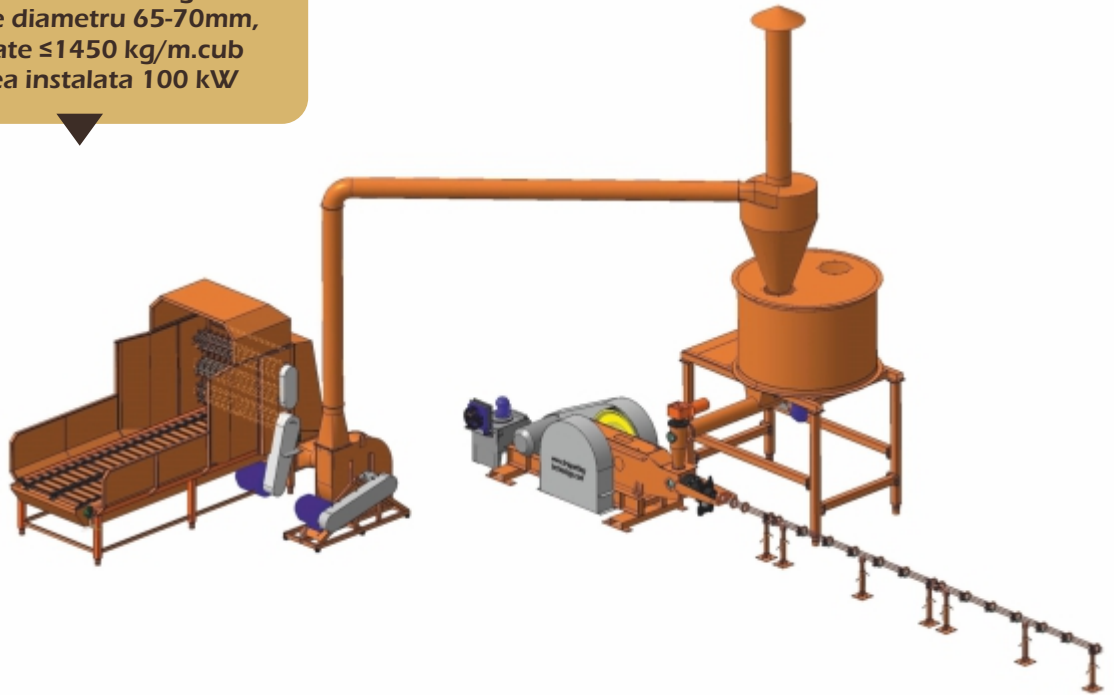

Capacitate productie
≤600-800 kg/ora brichete
Brichete din resturi vegetale
Brichete diametru 70-75mm,
densitate ≤1450 kg/m.cub
Puterea instalata 130 kW

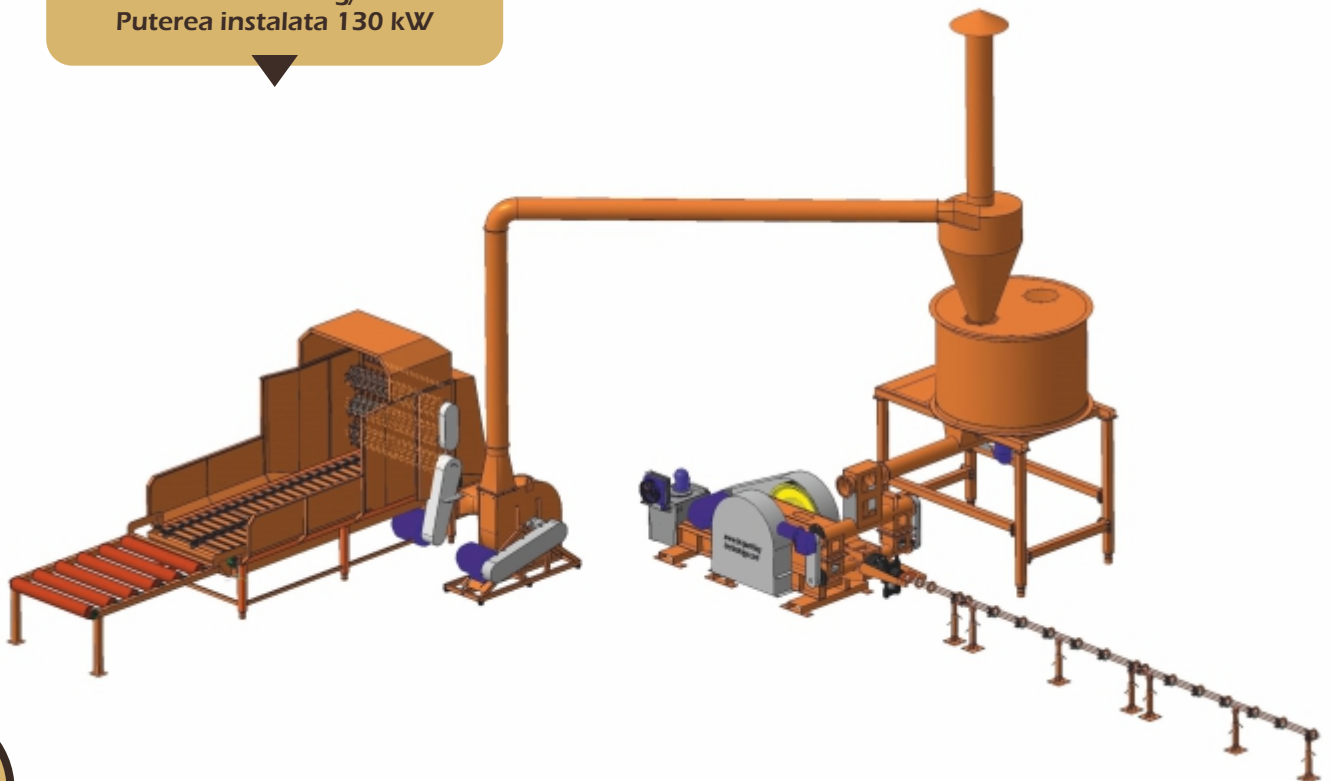

ASIGURAM MENTENANTA, SERVICE, PIESE DE SCHIMB



Linie brichetare paie seria "BriqTech"

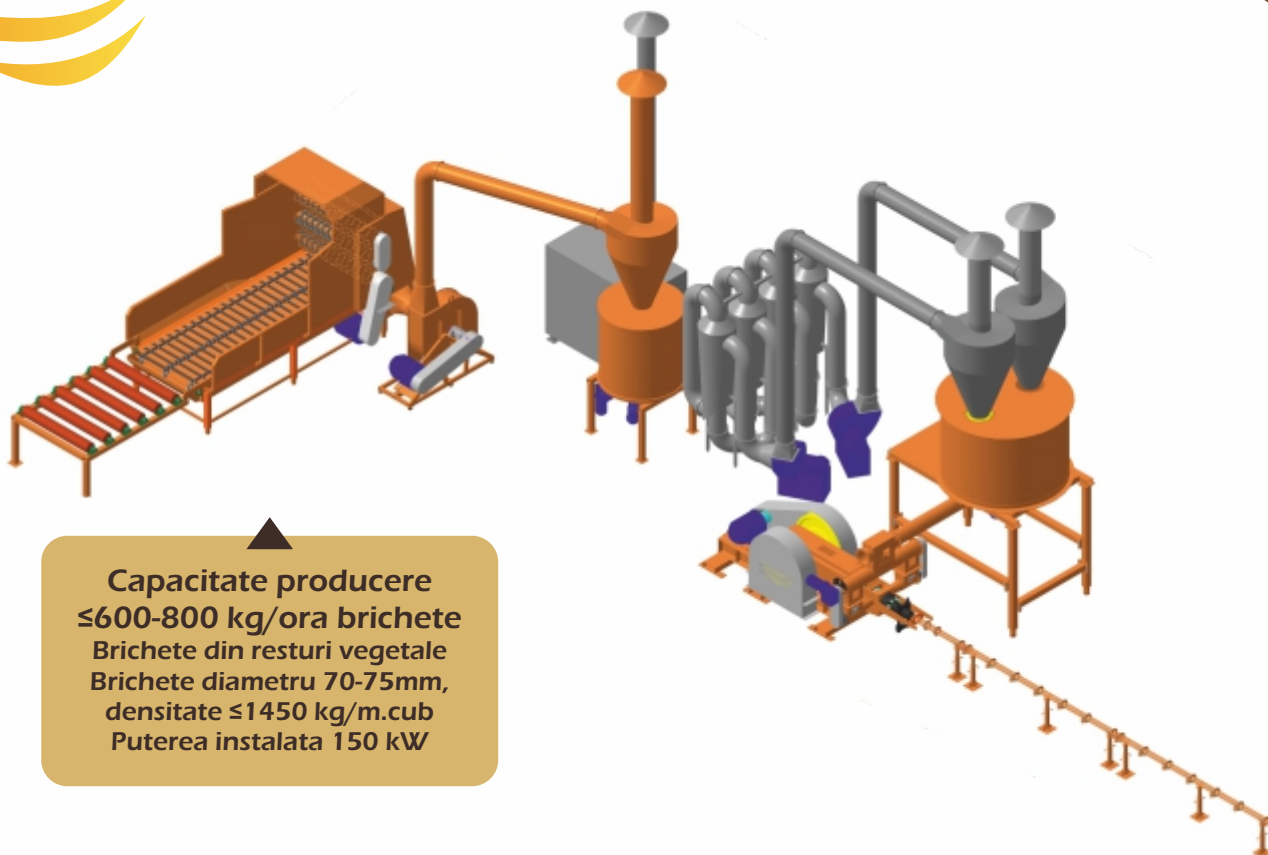

Capacitate producere
≤1200-1400 kg/ora brichete
Brichete din resturi vegetale
Brichete diametru 70-75mm,
densitate ≤1450 kg/m.cub
Puterea instalata 200 kW

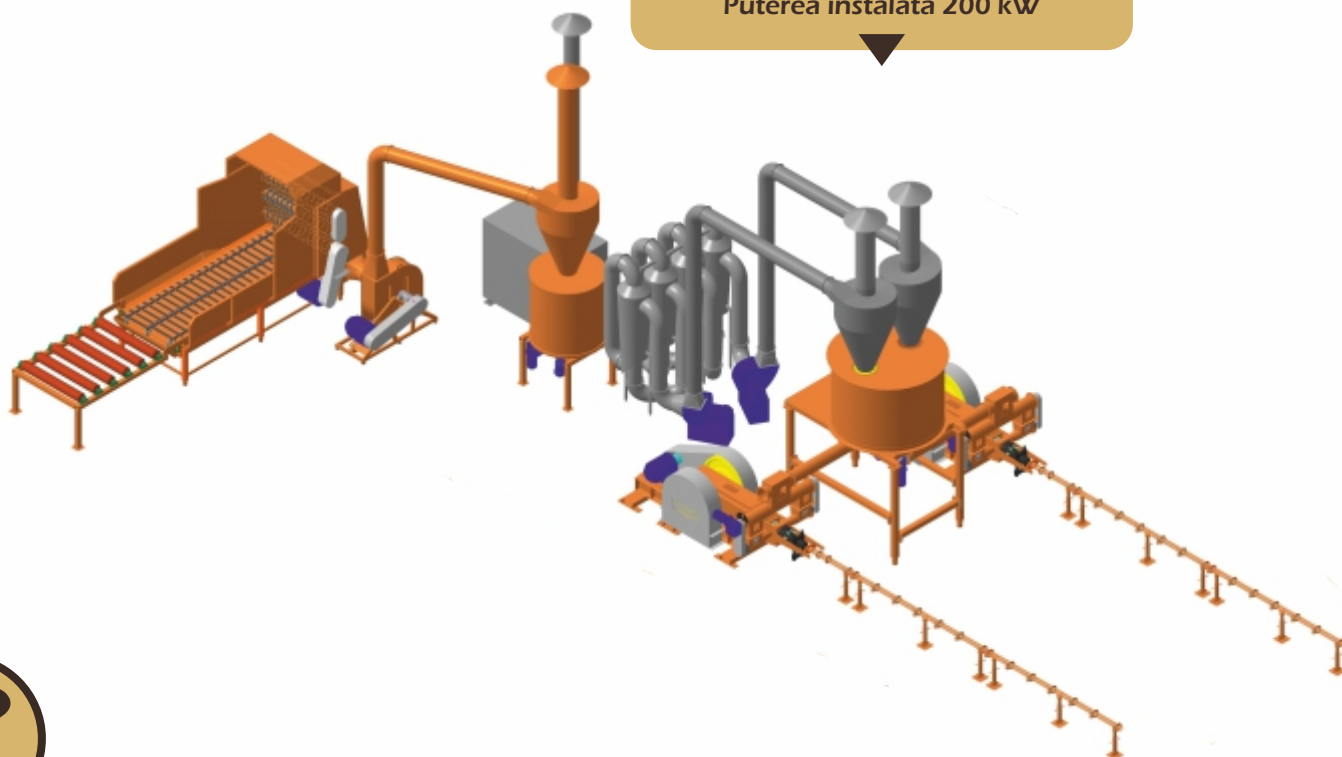

Linie mixta brichetare si peletizare paie seria "BriqTech" si "PelletTech"



Capacitate productie $\leq 500-700$ kg/ora peleti

Peleti din resturi vegetale

Peleti diametru 8mm, densitate ≤ 1350 kg/m.cub

Capacitate productie $\leq 600-800$ kg/ora brichete

Brichete din resturi vegetale

Brichete diametru 70-75mm, densitate ≤ 1450 kg/m.cub

Puterea instalata 200 kW

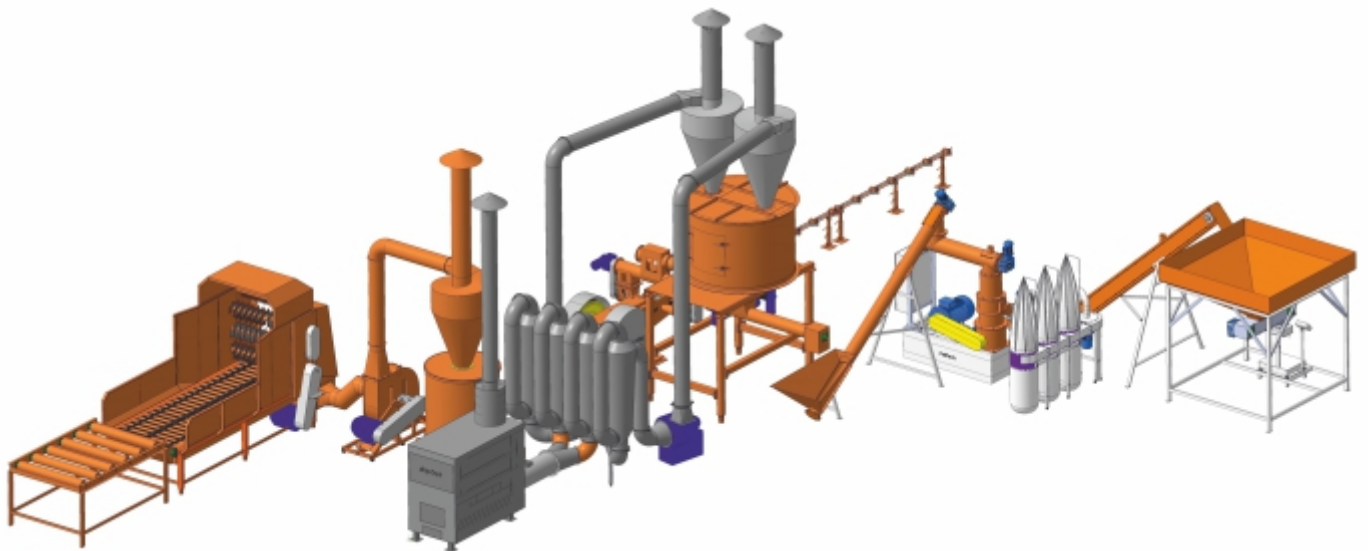

ASIGURAM MENTENANTA, SERVICE, PIESE DE SCHIMB



Linie peletizare paie seria "PelITech"



Capacitate producere $\leq 500-700$ kg/ora peleti
Peleti din resturi vegetale
Peleti diametru 8mm, densitate ≤ 1350 kg/m.cub
Puterea instalata 150 kW

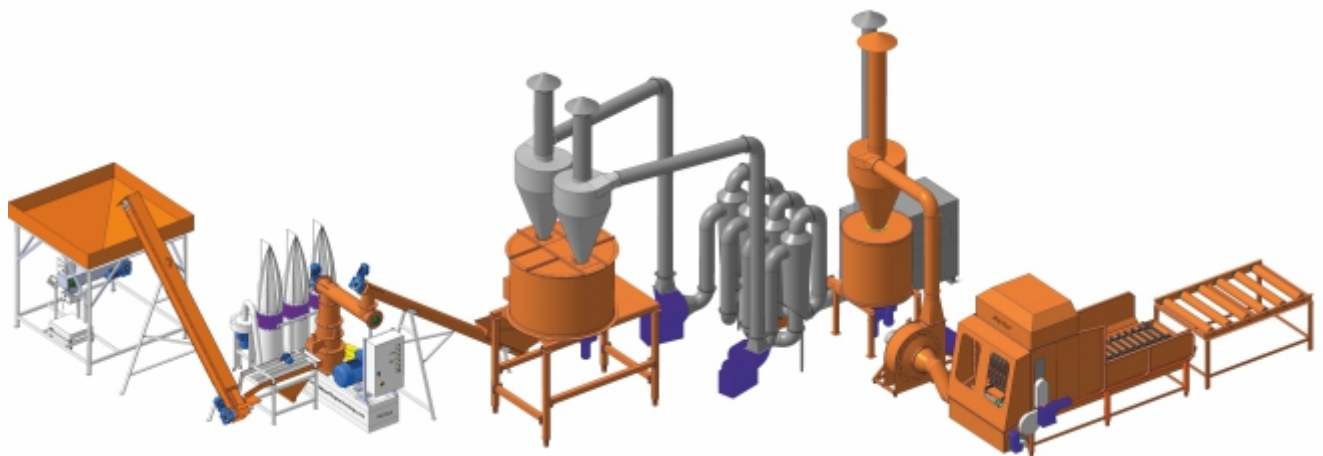

ASIGURAM MENTENANTA, SERVICE, PIESE DE SCHIMB



Presă mecanică brichetat biomasa

Presă mecanică brichetat biomasa
Seria "BriqTech" BT-050-200
Capacitatea de producere
≤250 kg/ora brichete,
Diametru 60mm Puterea instalată 25 kW

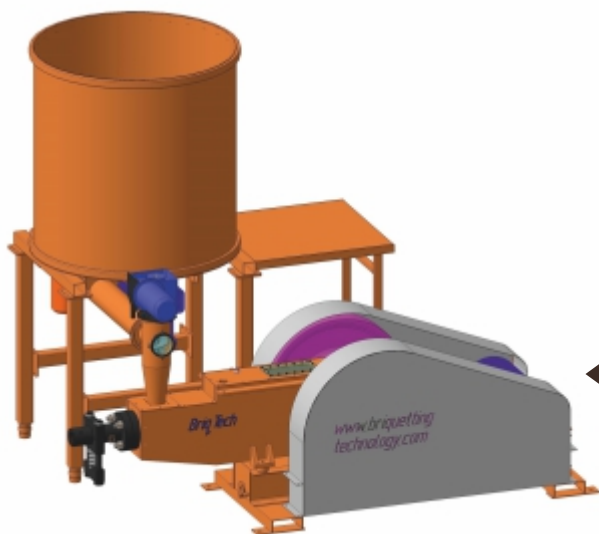
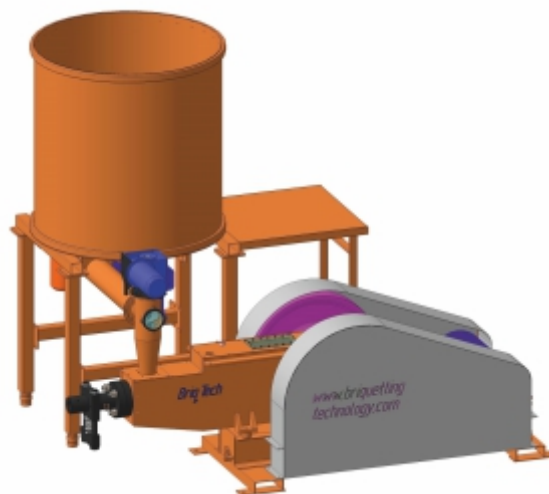

Presă mecanică brichetat biomasa
Seria "BriqTech" BT-060-400
Capacitatea de producere
≤300-400 kg/ora brichete,
Diametru 60-65mm Puterea instalată 30 kW

Presă mecanică brichetat biomasa
Seria "BriqTech" BT-065-500
Capacitatea de producere
≤400-500 kg/ora brichete,
Diametru 65-70mm Puterea instalată 40 kW

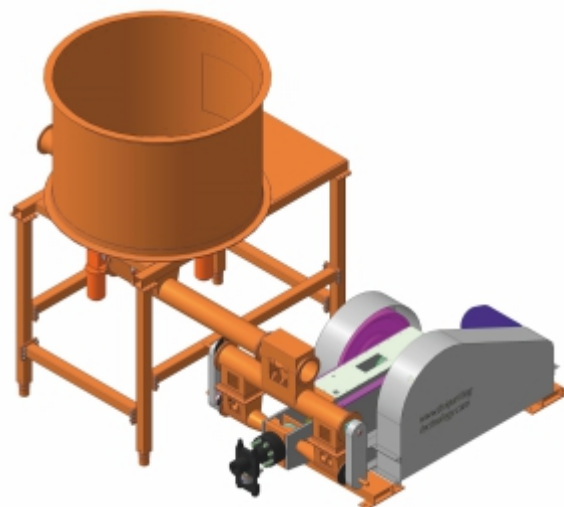

Presă mecanică brichetat biomasa
Seria "BriqTech" BT-070-800Max
Capacitatea de producere
≤600-800 kg/ora brichete,
Diametru 70-75mm Puterea instalată 55 kW

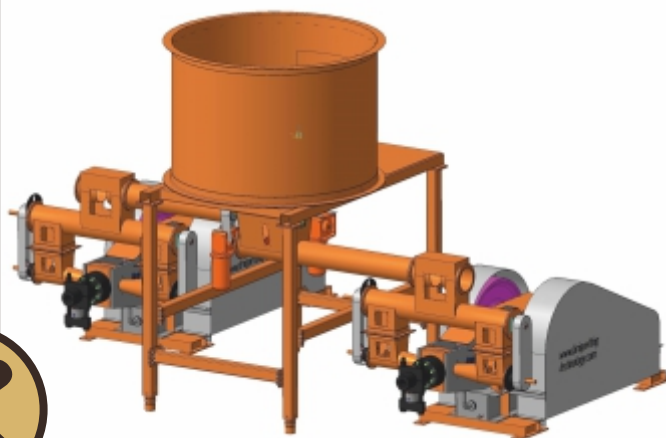

Presă mecanică brichetat biomasa
Seria "BriqTech" BT-070-800Max Duo
Capacitatea de producere
≤1200-1600 kg/ora brichete,
Diametru 70-75mm Puterea instalată 110 kW

ASIGURAM MENTENANTA, SERVICE, PIESE DE SCHIMB



Presă peleti "PelITech"

Presă peleti Seria "PelITech"
model: GFD-0.2 Fermier
Capacitatea de producere
 ≤ 250 kg/ora peleti,
Diametru 6,8mm Puterea instalată 18.5 kW

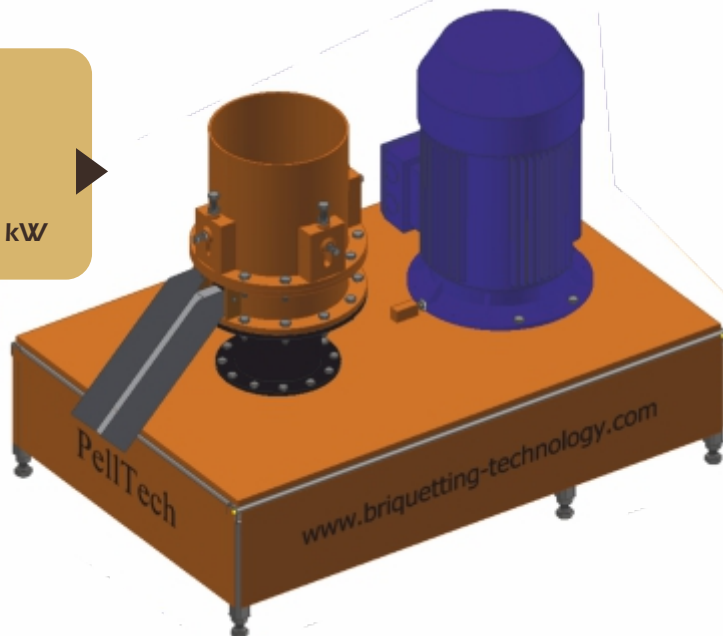

Presă peleti Seria "PelITech"
model: GFD-0.4 Fermier
Capacitatea de producere
 $\leq 300-400$ kg/ora peleti,
Diametru 6,8mm Puterea instalată 30 kW

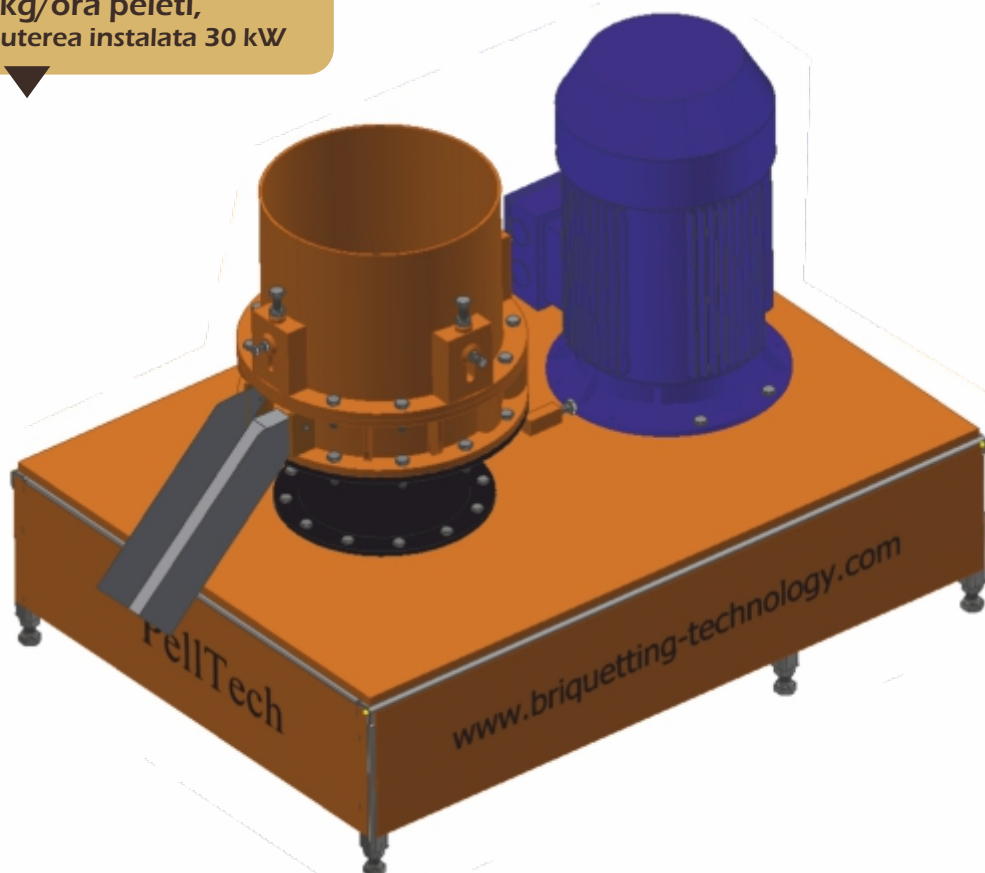

ASIGURAM MENTENANTA, SERVICE, PIESE DE SCHIMB



Minicomplex Presa peleti "PelTech"

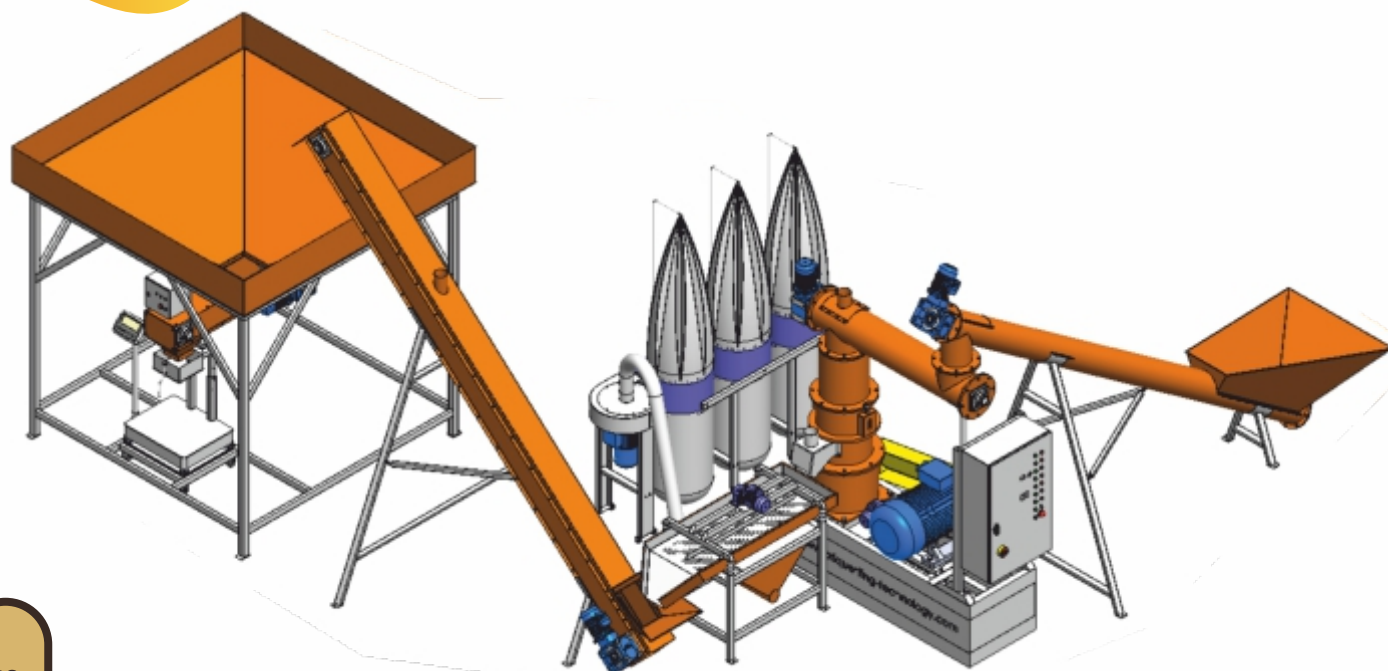

Minicomplex Presa peleti
Seria "PelTech" model: GFD-0.7
Capacitatea de producere
≤500-700 kg/ora peleti,
Diametru 6,8mm Puterea instalata 55 kW

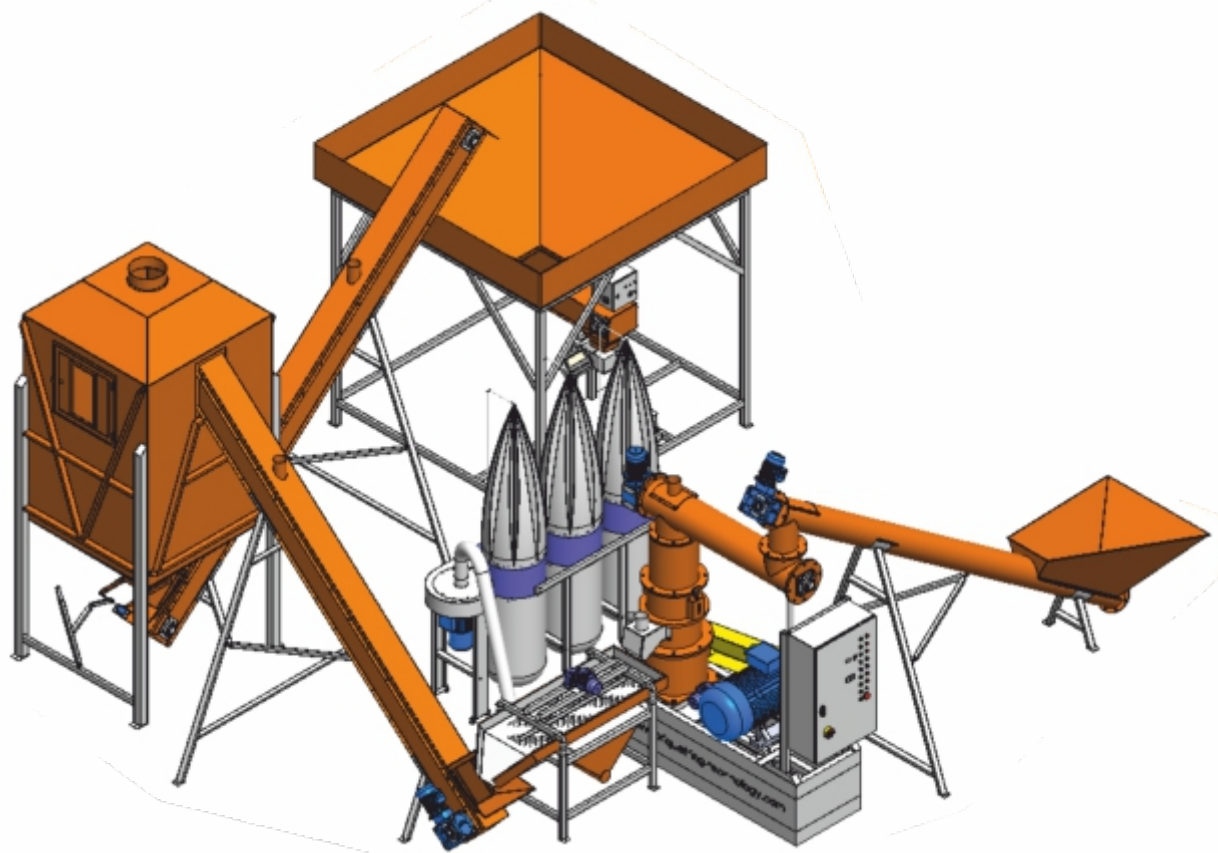

ASIGURAM MENTENANTA, SERVICE, PIESE DE SCHIMB



Minicomplex Presa peleti "PelITech"

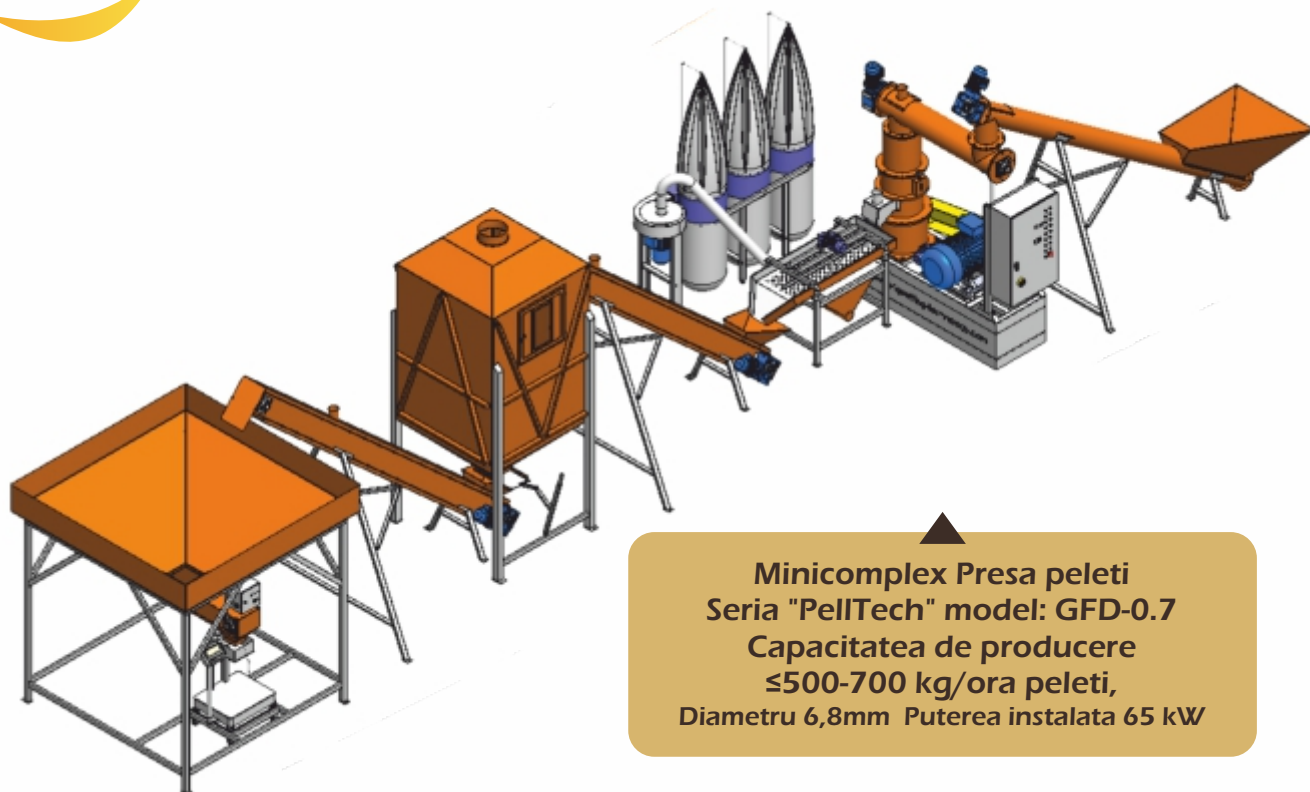

Minicomplex Presa peleti
Seria "PelITech" model: GFD-0.7
Capacitatea de productie
 $\leq 500-700$ kg/ora peleti,
Diametru 6,8mm Puterea instalata 65 kW

Minicomplex Presa peleti
Seria "PelITech" model: GFD-0.8
Capacitatea de productie
 $\leq 1000-1400$ kg/ora peleti,
Diametru 6,8mm Puterea instalata 110 kW

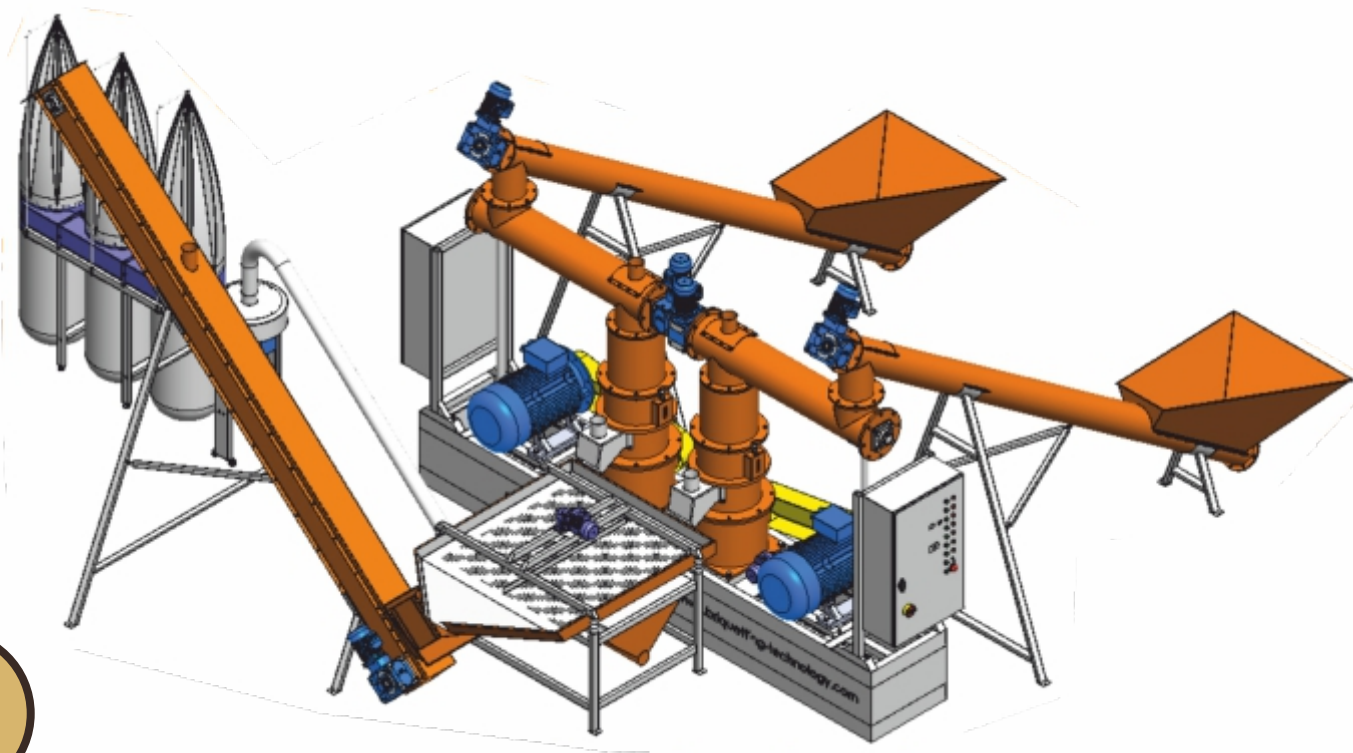

ASIGURAM MENTENANTA, SERVICE, PIESE DE SCHIMB



Presă peleti "PelITech"

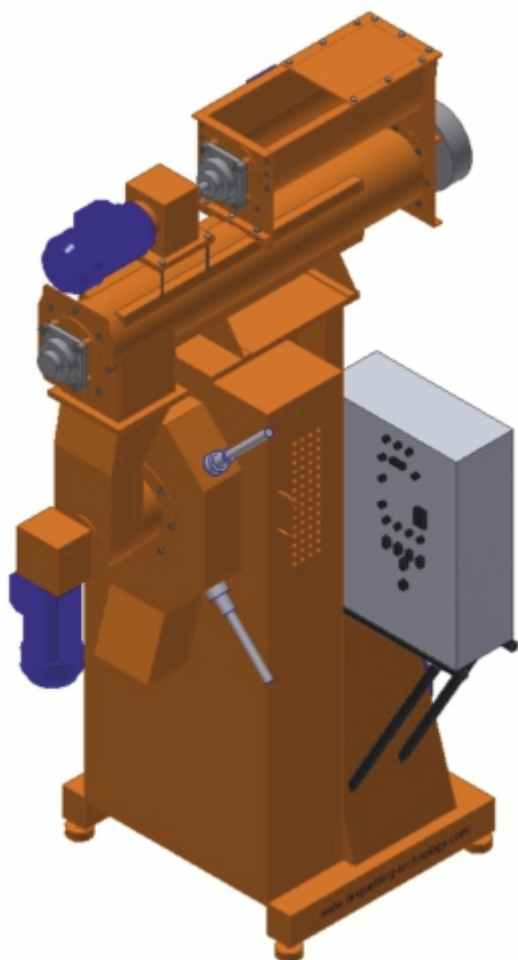

Presă peleti Seria "PelITech"
model: GRD-0.5
Capacitatea de producere
≤250 kg/ora peleti,
Diametru 6,8mm Puterea instalată 25 kW

ASIGURAM MENTENANTA, SERVICE, PIESE DE SCHIMB

Presă peleti Seria "PelITech"
model: GRD-1.5
Capacitatea de producere
≤900-1300 kg/ora peleti,
Diametru 6,8mm Puterea instalată 100/120 kW

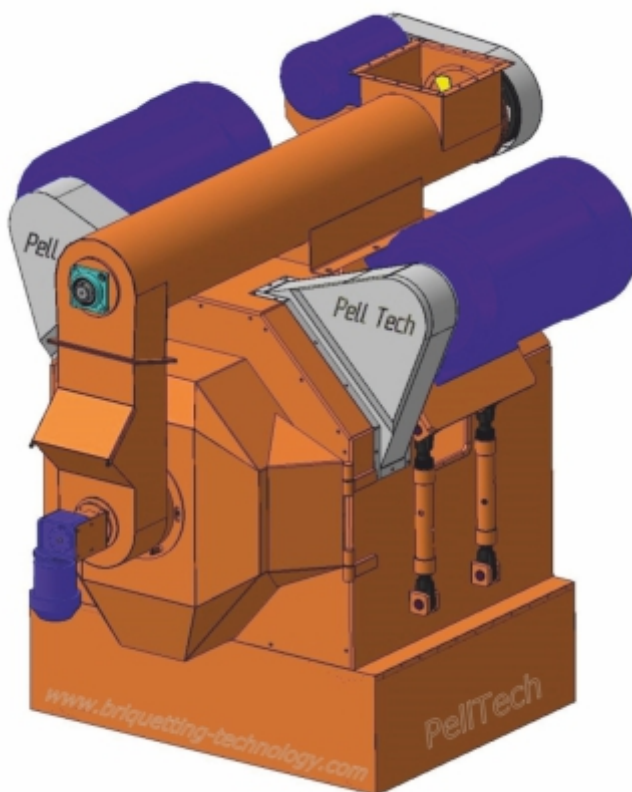

Presă peleti Münch Edelstahl GmbH Germania



ASIGURAM MENTENANTA, SERVICE, PIESE DE SCHIMB

Presă peleti
RMP-350

capacitate producere
≤500-800 kg peleti/ora

Presă peleti
RMP-420

capacitate producere
≤1500 kg peleti/ora

Presă peleti
RMP-520

capacitate producere
≤2000 kg peleti/ora





Presă peleti AM-TEHNOLOG Serbia



ASIGURAM MENTENANTA, SERVICE, PIESE DE SCHIMB

Presă peleti
AMP-304

capacitate producere
≤400-600 kg peleti/ora

Presă peleti
AMP-350

capacitate producere
≤600-800 kg peleti/ora

Presă peleti
AMP-420

capacitate producere
≤900-1300 kg peleti/ora



Complex tocare paie



Complex tocare baloti paie CGS-1

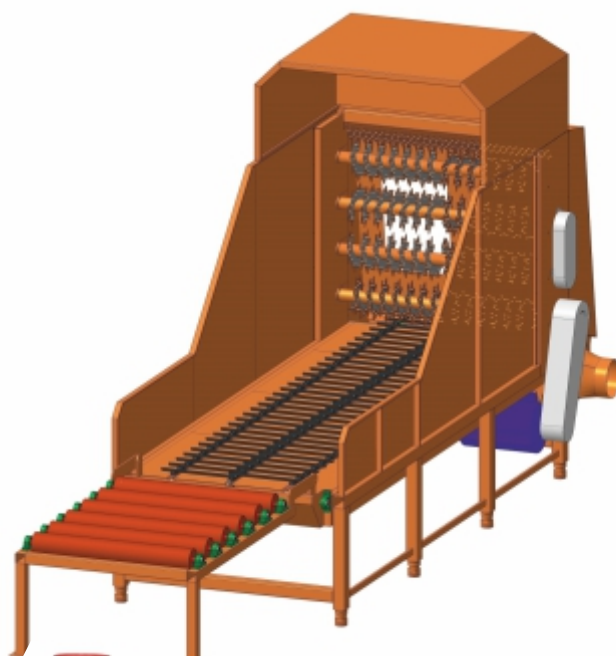

Complex tocare baloti paie CGS-2



Moara cu ciocanele 11,45 kW

ASIGURAM MENTENANTA, SERVICE, PIESE DE SCHIMB



Reciclare deseuri - Shredder

Tocator Resturi Forestiere Robust



ASIGURAM MENTENANTA, SERVICE, PIESE DE SCHIMB

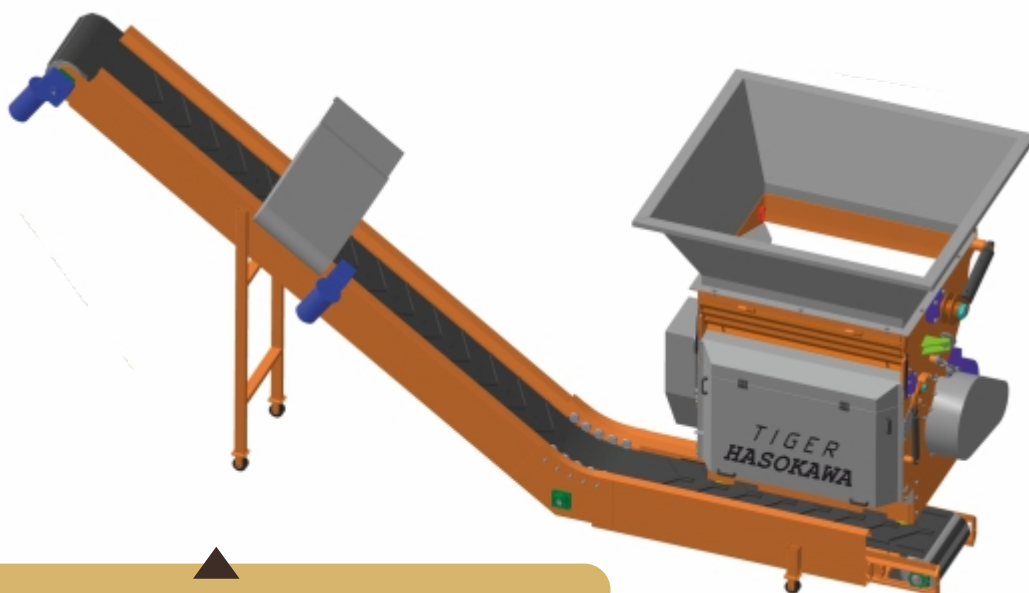

Tocator Paleti - Butuci De Lemn Seria "Tiger"

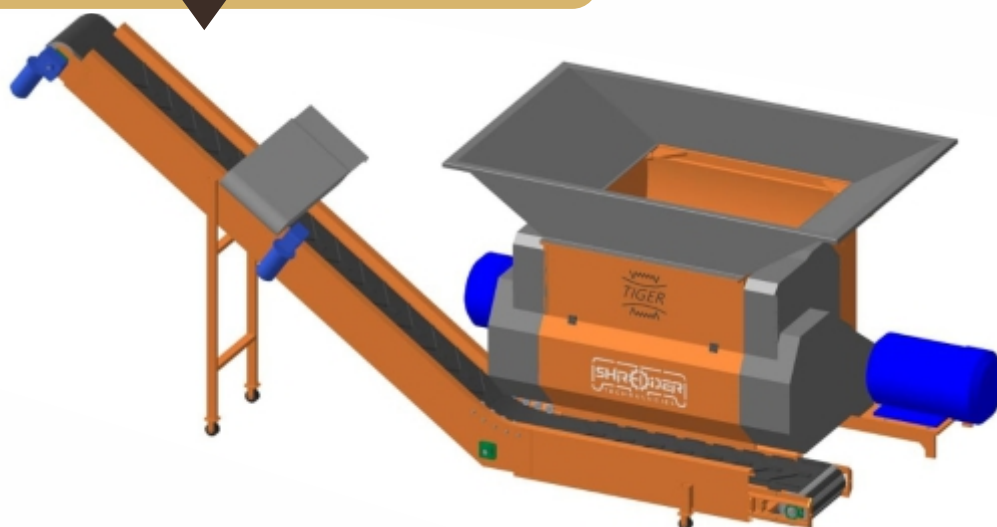

Uscator aerodinamic

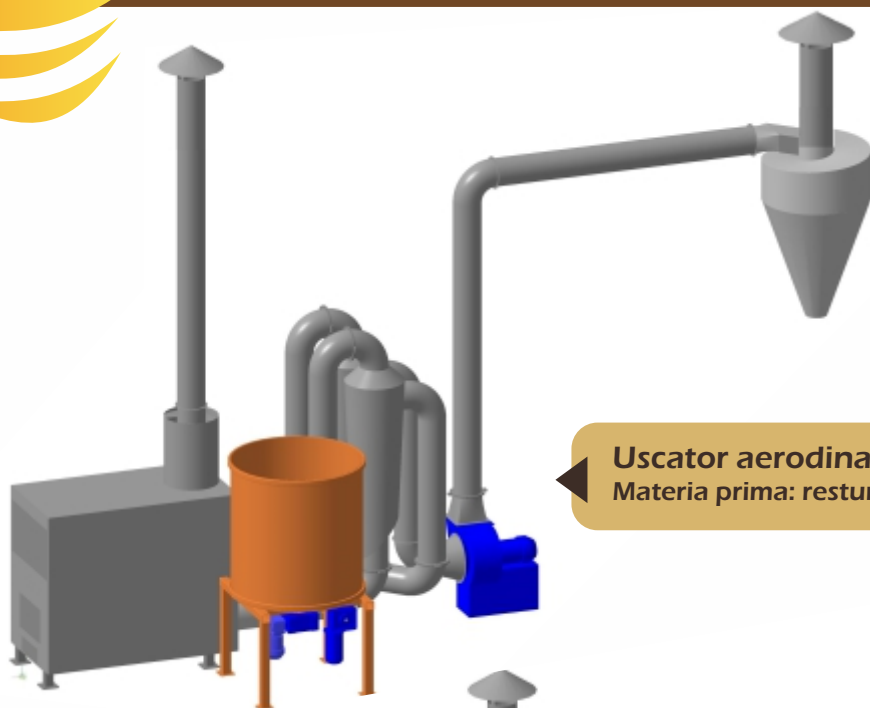

Uscator aerodinamic DAD-0.4-0.8
Materia prima: resturi vegetale

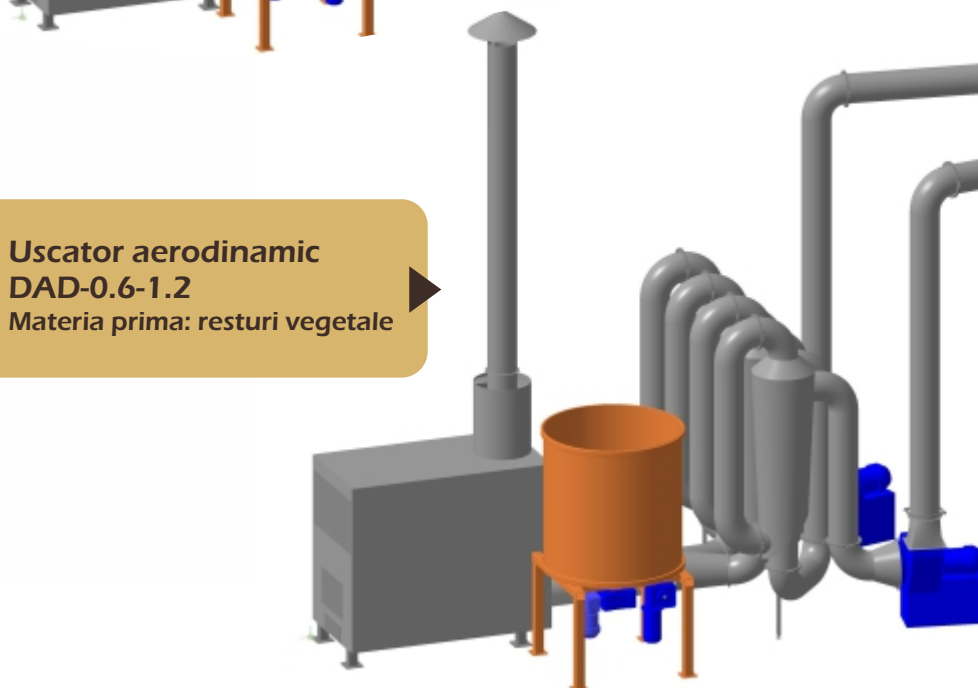

Uscator aerodinamic
DAD-0.6-1.2
Materia prima: resturi vegetale

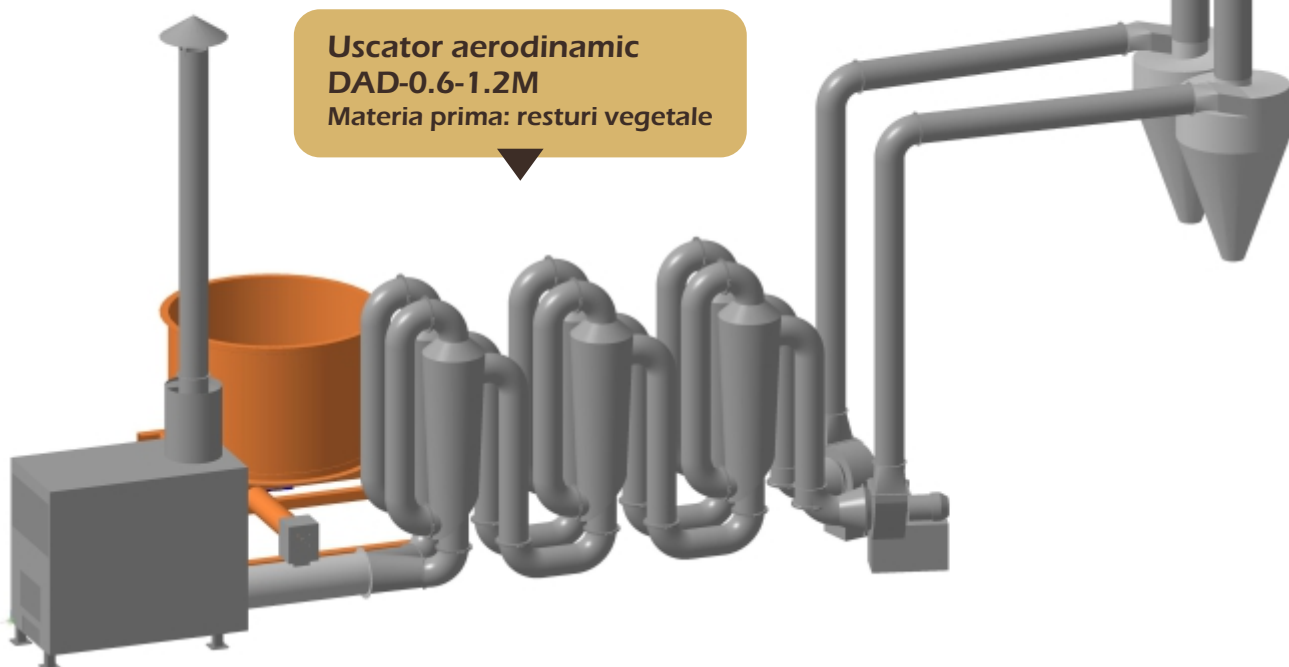

Uscator aerodinamic
DAD-0.6-1.2M
Materia prima: resturi vegetale

ASIGURAM MENTENANTA, SERVICE, PIESE DE SCHIMB



Uscator Strazar Pellet



Uscator cu Banda Biomasa
Materia prima: lucerna, canepa, etc.



Uscator rotativ
Materia prima: biomasa

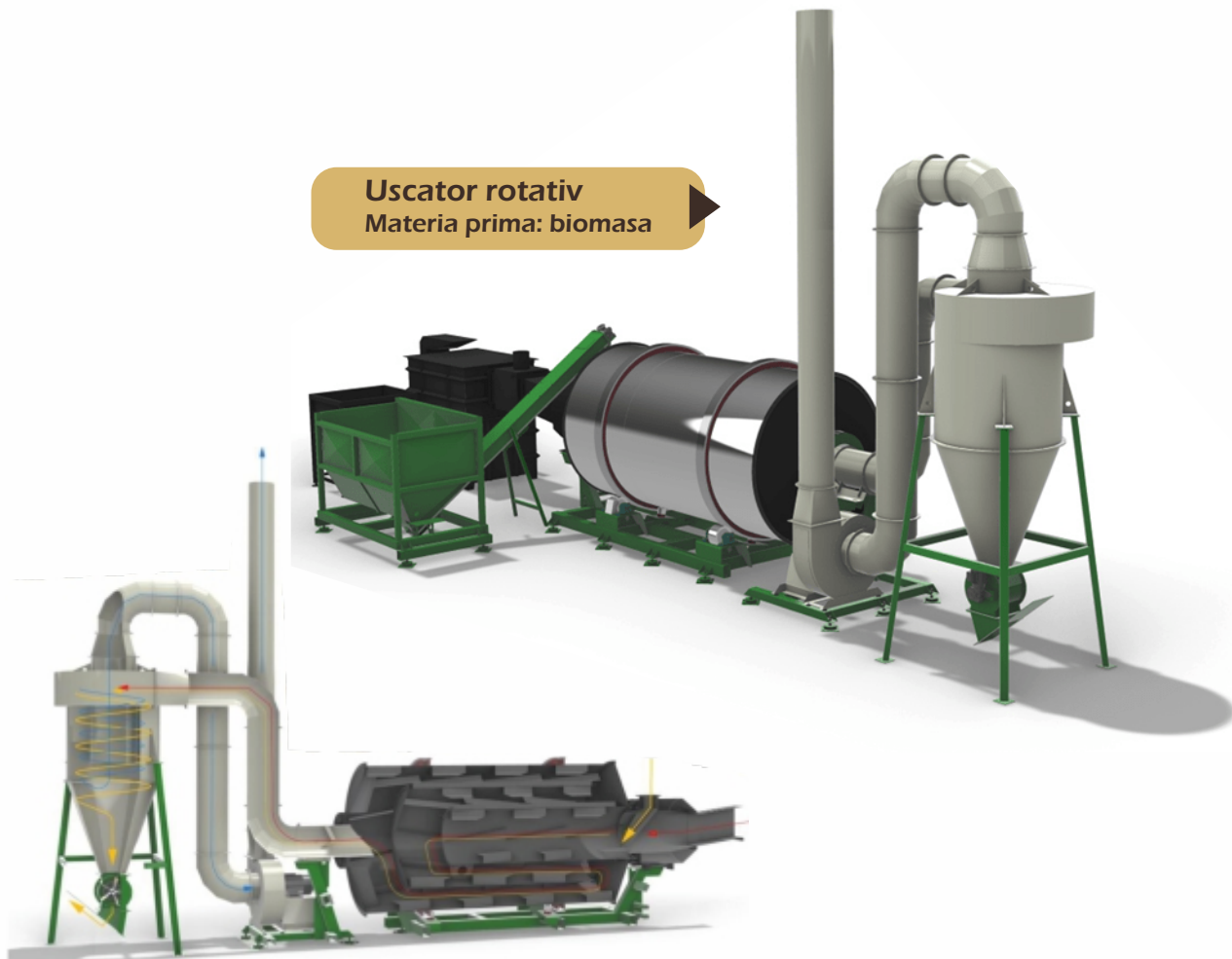

ASIGURAM MENTENANTA, SERVICE, PIESE DE SCHIMB



10 ANI DE ACTIVITATE!



**125 de proiecte
predate la cheie
pana acum!**

Mai multe detalii pe: www.agrobiobrichet.ro

ASIGURAM MENTENANTA, SERVICE, PIESE DE SCHIMB



Note



AGROBI
BRICHET
energie din biomasa

DOZAGRO
MASZYNY ROLNICZE



STRAZAR **PELLET**

RUBUST 

 **ČELIK PAK**

AM TEHNOLOG
PRODUCTION OF INDUSTRIAL EQUIPMENT

 **ARJES**
Recycling Innovation

Teagle

www.agrobibrichet.ro e-mail: office@agrobibrichet.ro
Tel.: +40765701050